

LP-150

ARM Pico-ITX Motherboard

User's Manual

Edition 1.01

2018/03/12



Copyright

Copyright 2017, all rights reserved. This document is copyrighted and all rights are reserved. The information in this document is subject to change without prior notice to make improvements to the products.

This document contains proprietary information and protected by copyright. No part of this document may be reproduced, copied, or translated in any form or any means without prior written permission of the manufacturer.

All trademarks and/or registered trademarks contains in this document are property of their respective owners.

Disclaimer

The company shall not be liable for any incidental or consequential damages resulting from the performance or use of this product.

The company does not issue a warranty of any kind, express or implied, including without limitation implied warranties of merchantability or fitness for a particular purpose.

The company has the right to revise the manual or include changes in the specifications of the product described within it at any time without notice and without obligation to notify any person of such revision or changes.

Trademark

All trademarks are the property of their respective holders.

Any questions please visit our website at <http://www.commell.com.tw>

Packing List:

Please check the package content before you starting using the board.



1 x LP-150 Motherboard

Optional:



1 xDC Input Power Cable
(OALDC-B / 1040513)



1 x Audio cable
(OALPJ-HDUNB / 1040123)

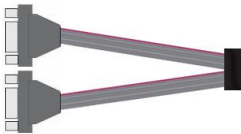

1 x Dual COM cable
(OALES-BKU2NB / 1040090)

Index

Chapter 1 <Introduction>	4
1.1 <Product Overview>	4
1.2 <Product Specification>	5
1.3 <Block Diagram>	6
Chapter 2 <Hardware setup>	7
2.1 <Connector Location and Reference>	7
2.1.1 <Internal connectors list>	8
2.1.2 <External connectors list>	8
2.2 <I/O Interface>	9
2.2.1 <Audio Interface>	9
2.2.2 <Debug Interface>	10
2.2.3 <RTC Interface>	10
2.2.4 <GPIO Interface>	11
2.2.5 <Expend GPIO Interface>	12
2.2.6 <UART Interface>	13
2.2.7 <RS-232 Interface>	14
2.2.8 <Push Button>	15
2.2.9 <CVBS Interface>	15
2.2.10 <Touch Panel Interface>	16
2.2.11 <FPC Touch Interface> Shared with J27	16
2.2.12 <LVDS Interface>	17
2.2.13 <FPC LCD Inverter Interface> Shared with J35	18
2.2.14 <LCD Inverter Interface>	19
2.2.15 <Power supply>	20
Contact information	21

Chapter 1 <Introduction>

1.1 <Product Overview>

LP-150 is a Pico motherboard that based on Rockchip RK3128 high performance Quad-core application processor to implement most useful features and functionalities of this integrated processor. This motherboard is designed to be a development board for customers to implement and verify their applications for RK3128 features.

The RK3128 Quad-core Cortex-A7 is integrates with separately Neon and FPU coprocessor, also shared 256KB L2 Cache. Mali400 MP2 GPU is embedded to support smoothly high-resolution (1080p) display and mainstream game.

Lots of high-performance interface to get very flexible solution, such as multi-pipe display with HDMI1.4, TV Encoder. Crypto hardware is integrated for support security BOOT. 32bits DDR3/LPDDR2 provides high memory bandwidths for high-performance.

The device enables OEMs and ODMs to quickly bring to market devices featuring robust operating systems support, rich user interfaces, and high processing performance life through the maximum flexibility of a fully integrated mixed processor solution.

The Cortex-A7 processor builds on the energy-efficient 8-stage pipeline of the Cortex-A5 processor. It also benefits from an integrated L2 cache designed for low-power, with lower transaction latencies and improved OS support for cache maintenance. On top of this there is improved branch prediction and an improved memory system performance, with 64-bit load-store path, 128-bit AMBA 4 AXI buses and increased TLB size (256 entry, up from 128 entry for Cortex-A9 and Cortex-A5), increasing performance for large workloads such as web browsing.

In a 28nm process, the Cortex-A7 can run at 1.2-1.6GHz, has an area of 0.45mm² (with Floating-Point Unit, NEON and a 32KB L1 cache) and requires less than 100mW of total power in typical conditions. This lowest performance profile makes it an ideal standalone processor for a range of mobile devices, and means the Cortex-A7 can ultimately deliver similar performance to the Cortex-A9 processor at much higher levels of power efficiency.

1.2 <Product Specification>

System

Processor	Rockchip RK3128 Quad-core Cortex-A7
Speed	Cortex-A7@1.3 GHz
Memory	512MB DDR3
Real Time Clock	Integrated RTC onboard
GPU	Mali400 MP2 GPU is embedded

Display

HDMI	Integrated HDMI 1.4 output up to 1080P
Display	Default 1024x600 LVDS LCD panel
Display Interface	Default Capacitive 1024x600 touch screen

Software

OS	Compatible with Android 4.4.4
----	-------------------------------

I/O

Flash Support	1 x 8GB onboard eMMC, 1 x Micro SD card slot
Audio	RK3128 Built-in Stereo Audio CODEC
LAN	RTL8211E Ethernet Transceiver
Internal I/O	1 x Pin header for RS232 x 2, 1 x Pin header for UART x 3 1 x LVDS panel connector, 1 x LVDS inverter connector, 1 x Pin header for expand GPIO, 1 x RTC battery 1 x Audio pin header for line-out and MIC-in 1 x system reset, power LED
External I/O	1 x Micro SD card slot, 1 x HDMI port, 1 x USB Host 2.0 ports 1 x USB OTG 2.0 port, 1 x RJ-45 LAN port, 1 x CVBS Input 1 x 5V DC-in power

Mechanical & Environmental

Power Requirement	DC INPUT 5V
Size & Thickness	100mm x 72mm (L x W)
Temperature	Operating within 0°C~70°C (32°F~158°F) Storage within -20°C~80°C (-4°F~176°F)
Relative Humidity	10%~90%, non-condensing

1.3 <Block Diagram>

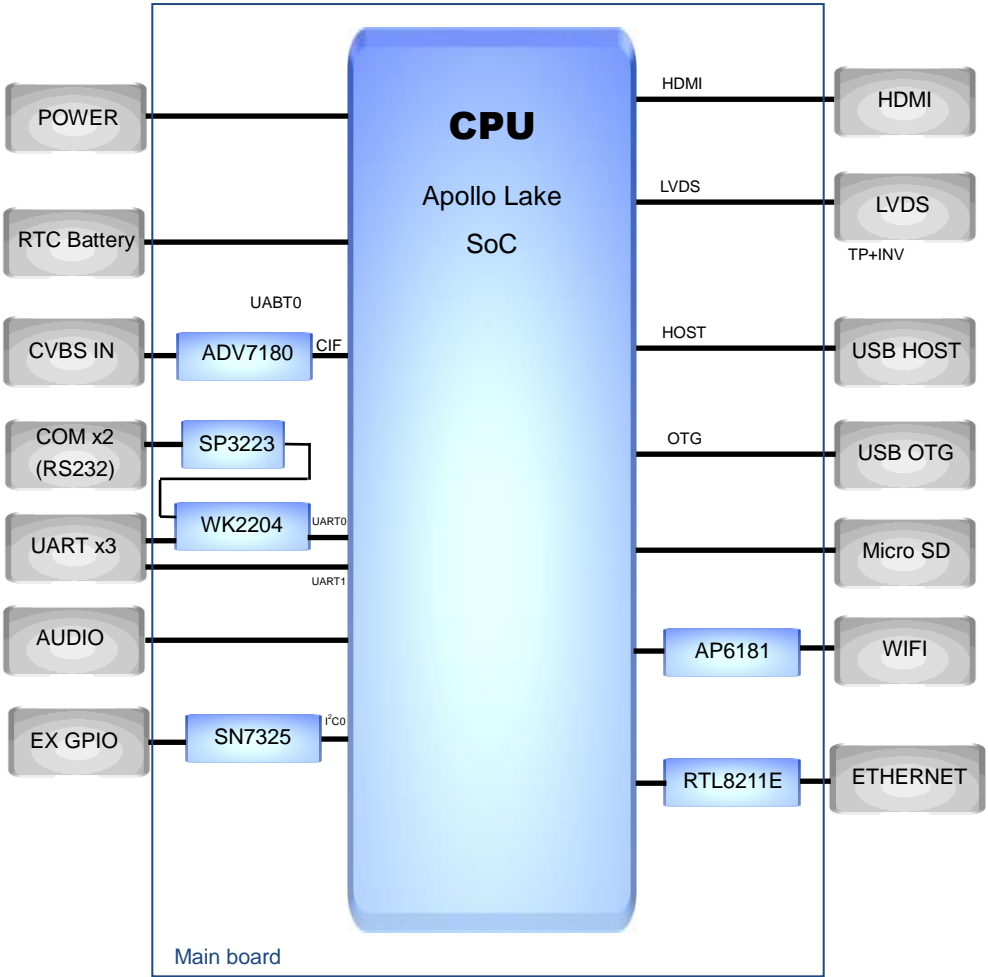

Chapter 2 <Hardware setup>

2.1 <Connector Location and Reference>

Top View

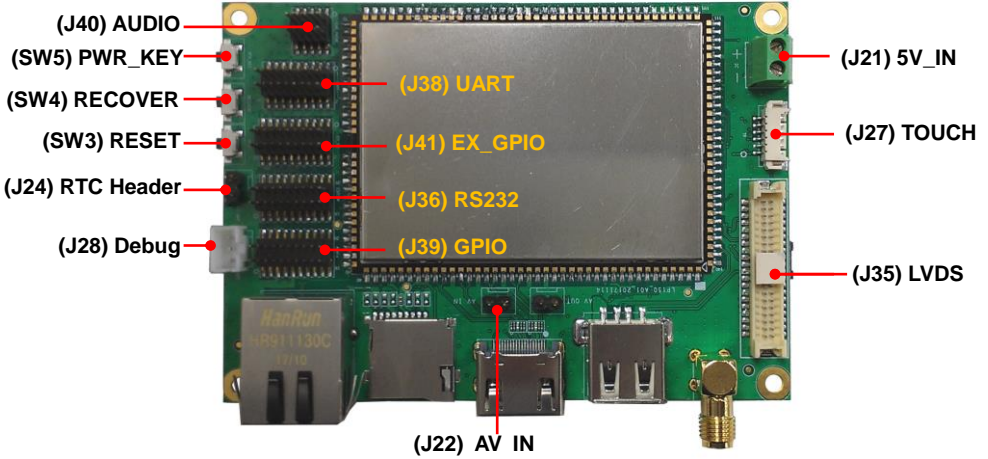

Bottom View

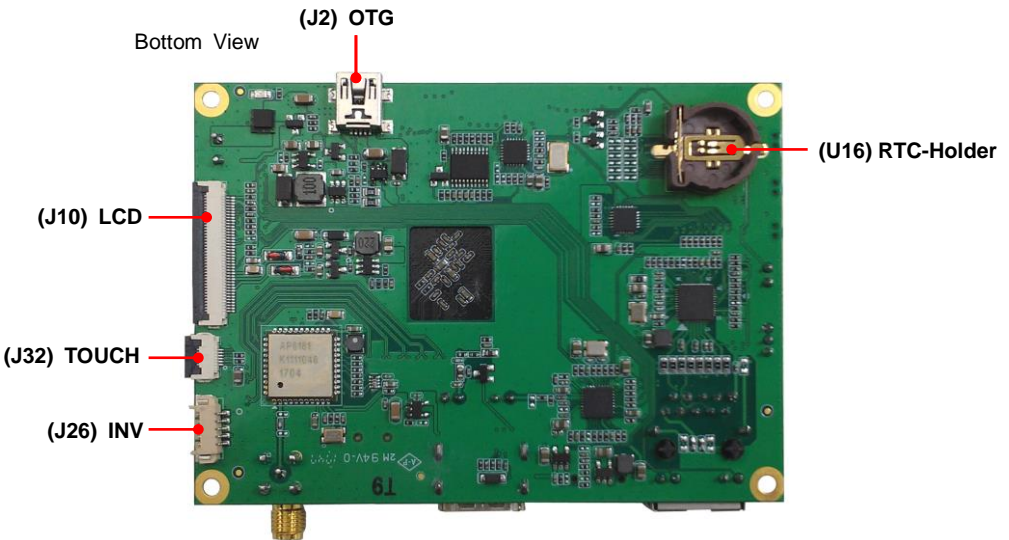

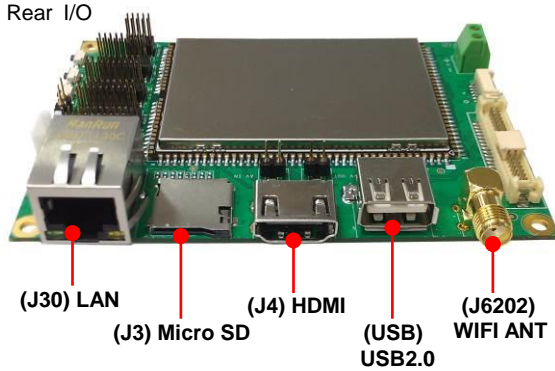

2.1.1 <Internal connectors list>

Connector	Function
J21	2-pin power input Terminal Block (5V Only)
J22	2-pin AV IN pin header
J27	6-pin Touch panel connector
J35	20 x 2-pin LVDS connector
J40	5 x 2-pin AUDIO pin header
J38	9 x 2-pin UART pin header
J41	10 x 2-pin External IO pin header
J36	10 x 2-pin RS-232 pin header
J39	10 x 2-pin GPIO pin header
SW5	Power button
SW4	Recovery button
SW3	Reset button
J24	2-pin RTC battery pin header
J28	2-pin DEBUG pin header
U16	RTC Battery holder
J10	40-pin FPC LCD panel connector
J32	6-pin FPC Touch panel connector
J26	5-pin LCD inverter connector

2.1.2 <External connectors list>

Connector	Function
J30	RJ45 LAN connector
J3	Micro SD connector
J4	HDMI connector
USB	USB Host 2.0 connector
J6202	WiFi SMA Antenna connector
J2	USB OTG 2.0 connector

2.2 <I/O Interface>

2.2.1 <Audio Interface>

J40 (AUDIO)

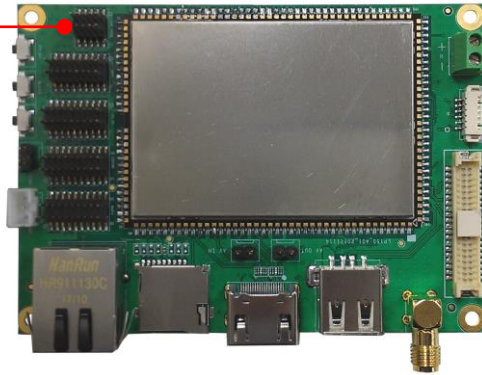
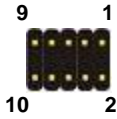

J40: Front panel audio 10-pin header (Pitch 1.27mm x 2.54mm)

Pin	Signal	Pin	Signal
1	MIC_IN-	2	GND
3	MIC_IN+	4	NC
5	HP_OUTR	6	NC
7	NC	8	NC
9	HP_OUTL	10	NC

2.2.2 <Debug Interface>

J28 (Debug)

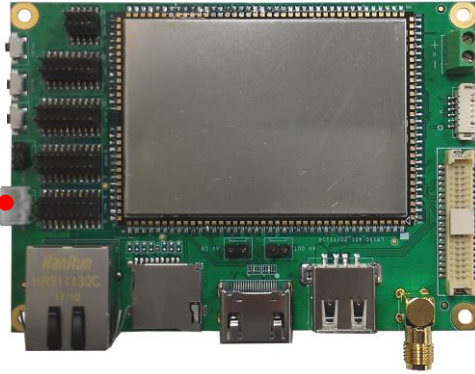

J28: Debug 3-pin connector

Pin	Signal
1	UART_TX
2	UART_RX
3	GND

2.2.3 <RTC Interface>

J24 (RTC Header)

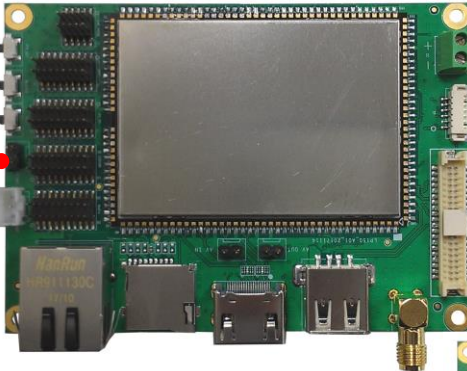

J24: RTC 2-pin connector (Pitch 2.54mm)

Pin	Signal
1	3.3V
2	GND

U16 (RTC-Holder)
CR1202 Compatible

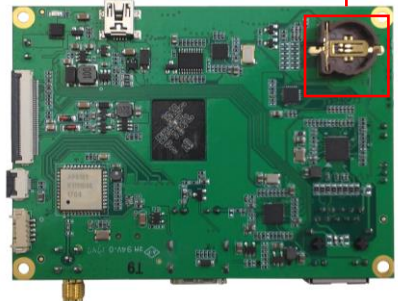

J24 and U16 are alternative to use

2.2.4 <GPIO Interface>

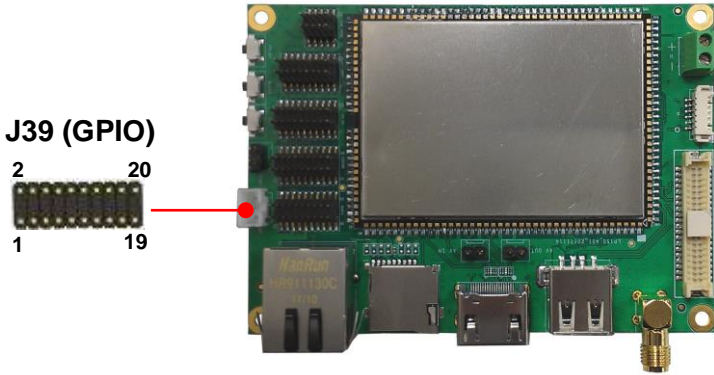

J39: GPIO 20-pin header (Pitch 1.27mm x 2.54mm)

Pin	Signal	Pin	Signal
1	I2S_SDO/SPI_RXD_GPIO0_B5	2	I2S_LRCK_RX/SPI_TXD_GPIO0_B3
3	I2S_SCLK/SPI_CLK_GPIO0_B1	4	I2S_SDI/SPI_CS0_GPIO0_B6
5	GND	6	GND
7	I2C0_SDA	8	I2C0_SCL
9	GND	10	NC
11	ADC2	12	ADC0
13	NC	14	NC
15	NC	16	NC
17	NC	18	NC
19	NC	20	NC

2.2.5 <Expend GPIO Interface>

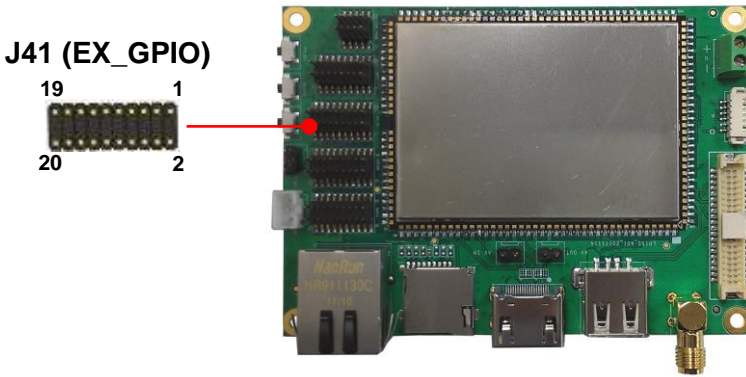

J41: 16bits EX_GPIO 20-pin header (Pitch 1.27mm x 2.54mm)

Pin	Signal	Pin	Signal
1	EX_GPIO1	2	EX_GPIO2
3	EX_GPIO3	4	EX_GPIO4
5	EX_GPIO5	6	EX_GPIO6
7	EX_GPIO7	8	EX_GPIO8
9	EX_GPIO9	10	EX_GPIO10
11	EX_GPIO11	12	EX_GPIO12
13	EX_GPIO13	14	EX_GPIO14
15	EX_GPIO15	16	EX_GPIO16
17	VCCIO(3.3V)	18	GND
19	VCCIO(3.3V)	20	GND

2.2.6 <UART Interface>

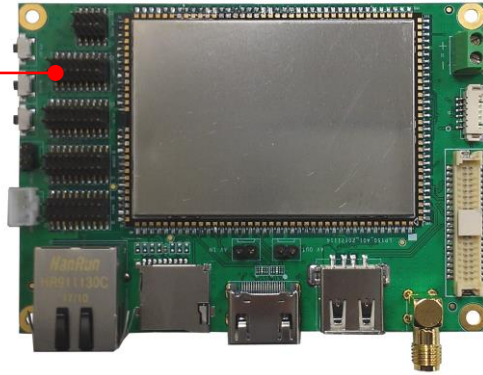
J38 (UART)

J38: 18-pin UART header (Pitch 1.27mm x 2.54mm)

Pin	Signal	Pin	Signal
1	UART1_RX_GPIO1_B2_SPI_RX	2	UART1_TX_GPIO1_B1_SPI_TX
3	UART1_RTS_GPIO1_B3_SPI_CSN	4	UART1_CTS_GPIO1_B0_SPI_CLK
5	GND	6	GND
7	UART_EX2_RX	8	UART_EX2_TX
9	UART_EX2_RTS	10	UART_EX2_CTS
11	GND	12	GND
13	UART_EX4_RX	14	UART_EX4_TX
15	UART_EX4_RTS	16	UART_EX4_CTS
17	GND	18	GND

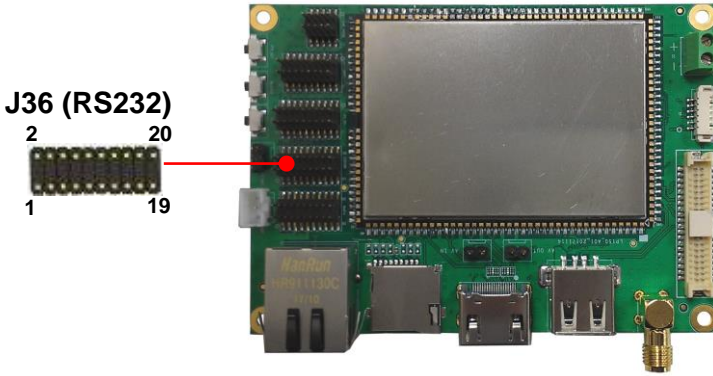
2.2.7 <RS-232 Interface>



J36: 20-pin RS232 header (Pitch 1.27mm x 2.54mm)

Pin	Signal	Pin	Signal
1	NC	2	232_1_RX
3	232_1_TX	4	NC
5	GND	6	NC
7	NC	8	NC
9	NC	10	NC
11	NC	12	232_2_RX
13	232_2_TX	14	NC
15	GND	16	NC
17	NC	18	NC
19	NC	20	NC

Note:

232_1_TX: direction input, from external device to RK3128.

232_2_TX: direction input, from external device to RK3128.

232_1_RX: direction output, from RK3128 to external device.

232_2_RX: direction output, from RK3128 to external device.

2.2.8 <Push Button>

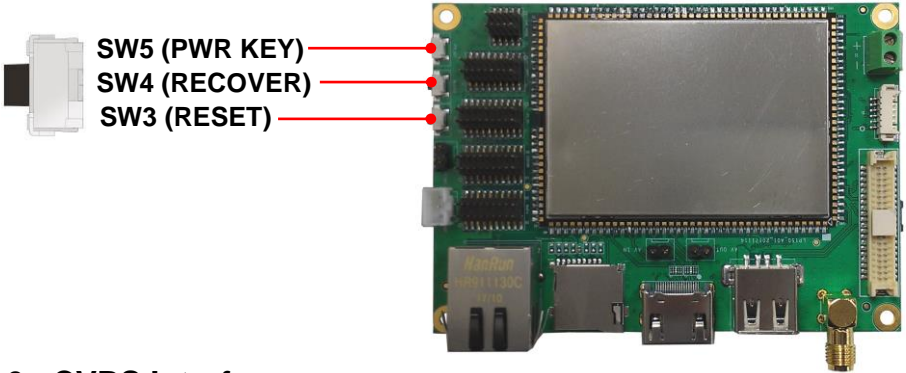

2.2.9 <CVBS Interface>

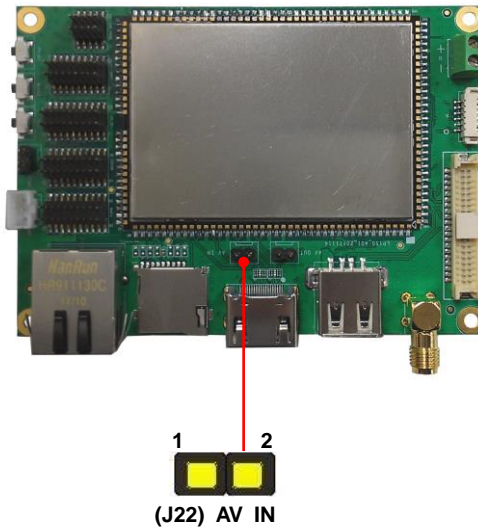

J22: 2-pin AV IN connector

Pin	Signal
1	CVBS IN
2	GND

2.2.10 <Touch Panel Interface>

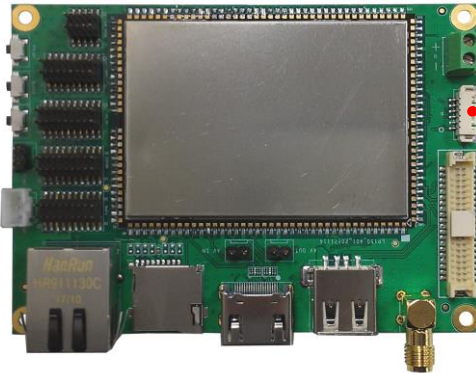

(J27) TOUCH

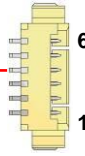

J27: 6-pin Touch panel connector
(Pitch 1.25mm)

Pin	Signal
1	VCCIO(3.3V)
2	GND
3	TP_INT
4	TP_RST
5	I2C0_SDA
6	I2C0_SCL

2.2.11 <FPC Touch Interface> Shared with J27

(J32) TOUCH

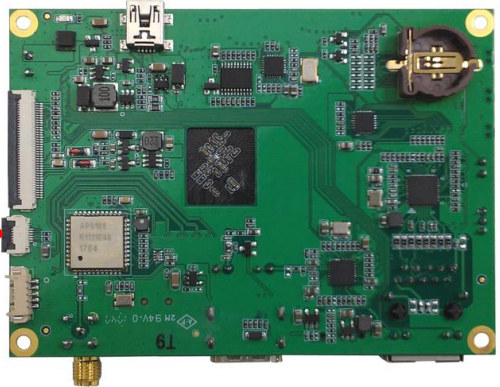
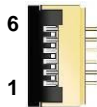

J32: 6-pin FPC Touch panel connector
(Pitch 1.25mm)

Pin	Signal
1	TP_RST
2	VCCIO(3.3V)
3	GND
4	TP_INT
5	I2C0_SDA
6	I2C0_SCL

2.2.12 <LVDS Interface>

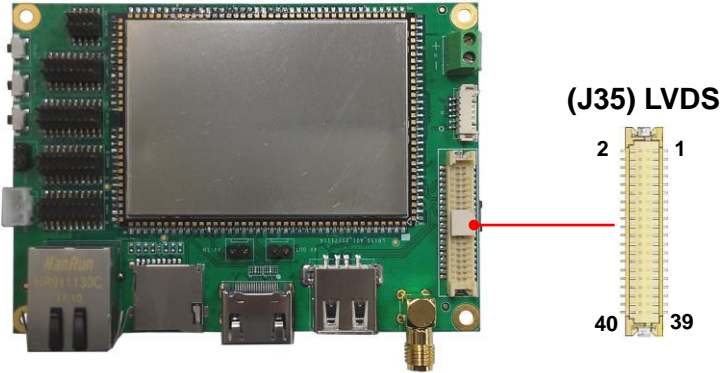

J35: LVDS 40-pin connector (Model: HIROSE DF13-40DP-1.25V compatible)

Pin	Signal	Pin	Signal
1	LCD_3V3	2	NC
3	NC	4	NC
5	NC	6	LVDS_0-
7	NC	8	LVDS_0+
9	NC	10	GND
11	NC	12	LVDS_1-
13	NC	14	LVDS_1+
15	NC	16	GND
17	NC	18	LVDS_2-
19	NC	20	LVDS_2+
21	NC	22	GND
23	NC	24	LVDS_CLK-
25	NC	26	LVDS_CLK+
27	NC	28	GND
29	NC	30	LVDS_3-
31	NC	32	LVDS_3+
33	NC	34	GND
35	LCD_RST	36	NC
37	LCD_STB	38	NC
39	NC	40	NC

2.2.13 <FPC LCD Inverter Interface> Shared with J35

(J10) LCD

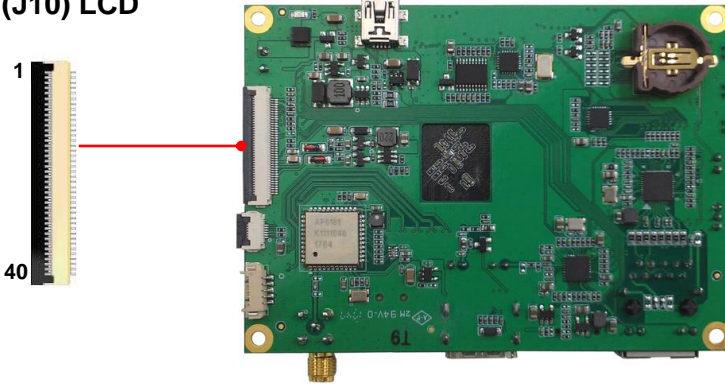

J10: 40-pin FPC LCD connector (Pitch 1.25mm)

Pin	Signal	Pin	Signal
1	VCOM	21	GND
2	LCD_3V3	22	LVDS_3-
3	LCD_3V3	23	LVDS_3+
4	NC	24	GND
5	LCD_RST	25	SELB
6	U_D	26	GND
7	L_R	27	AVDD
8	LCD_STB	28	GND
9	GND	29	VGH
10	LVDS_CLK-	30	NC
11	LVDS_CLK+	31	NC
12	GND	32	VGL
13	LVDS_0-	33	GND
14	LVDS_0+	34	NC
15	GND	35	VCC_LEDK
16	LVDS_1-	36	VCC_LEDK
17	LVDS_1+	37	NC
18	GND	38	NC
19	LVDS_2-	39	VCC_LED A
20	LVDS_2+	40	VCC_LED A

2.2.14 <LCD Inverter Interface>

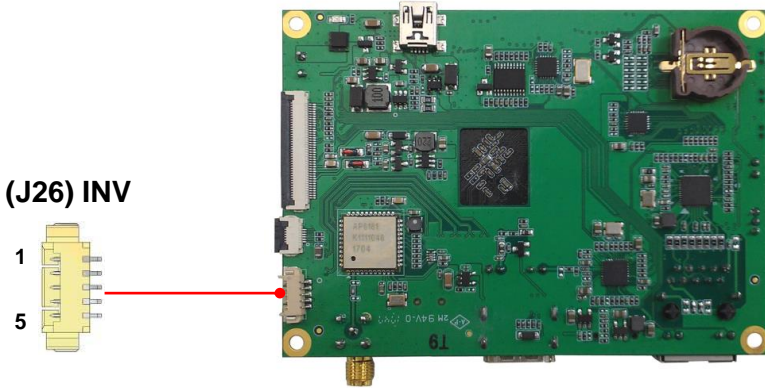

J26: 5-pin LCD inverter connector (Pitch 1.25mm)

Pin	Signal
1	LCD_5V
2	LCD_3V3
3	GND
4	VCC_LEDK
5	VCC_LEDA

2.2.15 <Power supply>

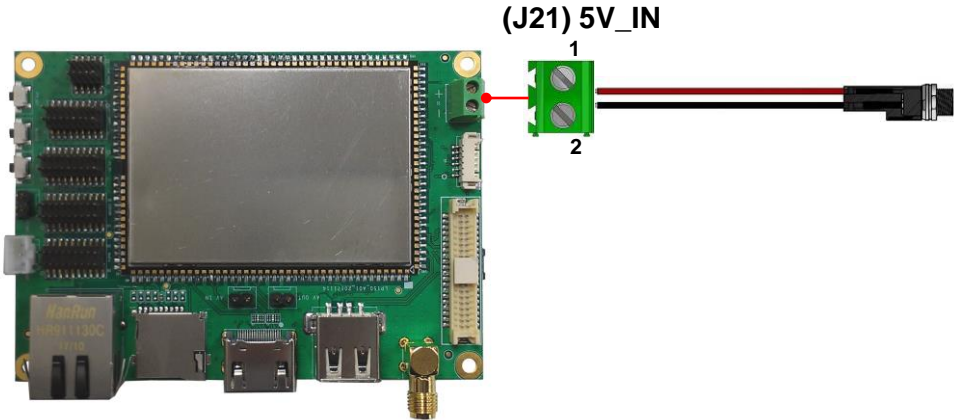

J21: Terminal Block 2-pin power connector

Pin	Signal	Pin	Signal
1	Power in (5V ONLY)	2	GND

Contact information

Any advice or comment about our products and service, or anything we can help you please don't hesitate to contact with us. We will do our best to support you for your products, projects and business.

Taiwan Commate computer Inc.

Address	19F., NO.94, Sec. 1, Xintai 5 th Rd., Xizhi Dist., New Taipei City 22102, Taiwan.
TEL	+886-2-26963909
Website	www.commell.com.tw
E-mail	info@commell.com.tw (General information) tech@commell.com.tw (Technical Support)

Commell is a brand name of Taiwan Commate computer Inc.